



INSTRUCTION MANUAL

VHF MARINE TRANSCEIVER IC-M304



Icom Inc.

FOREWORD

Thank you for purchasing this Icom radio. The IC-M304 VHF MARINE TRANSCEIVER is designed and built with Icom's state of the art technology and craftsmanship. With proper care, this radio should provide you with years of trouble-free operation.

We hope you agree with Icom's philosophy of "technology first." Many hours of research and development went into the design of your IC-M304.

◇ **FEATURES**

- *Large 2-digit Channel with scrolling comment*
- *New Force5Audio™ speaker*
- *Built-in DSC meets RTCM SC101 requirement*
- *Submersible construction*
- *Favorite channel function*
- *AquaQuake water draining function*

Icom, Icom Inc. and the ICOM logo are registered trademarks of Icom Incorporated (Japan) in the United States, the United Kingdom, Germany, France, Spain, Russia and/or other countries.

FORCE5AUDIO logo is a registered trademark of Icom Incorporated (Japan) in the United States.

IMPORTANT

READ ALL INSTRUCTIONS carefully and completely before using the transceiver.

SAVE THIS INSTRUCTION MANUAL — This instruction manual contains important operating instructions for the IC-M304.

EXPLICIT DEFINITIONS

WORD	DEFINITION
⚠ WARNING!	Personal injury, fire hazard or electric shock may occur.
CAUTION	Equipment damage may occur.
NOTE	Recommended for optimum use. No risk of personal injury, fire or electric shock.

<p>CLEAN THE TRANSCEIVER AND MICROPHONE THOROUGHLY WITH FRESH WATER after exposure to water including salt water, otherwise, the keys and switches may become inoperable due to salt crystallization.</p>
--

IN CASE OF EMERGENCY

If your vessel requires assistance, contact other vessels and the Coast Guard by sending a distress call on Channel 16.

USING CHANNEL 16

DISTRESS CALL PROCEDURE

1. "MAYDAY MAYDAY MAYDAY."
2. "THIS IS" (name of vessel)
3. Your call sign or other indication of the vessel (AND 9-digit DSC ID if you have one).
4. "LOCATED AT" (your position)
5. The nature of the distress and assistance required.
6. Any other information which might facilitate the rescue.

Or, transmit your distress call using digital selective calling on Channel 70.

USING DIGITAL SELECTIVE CALLING (Ch 70)

DISTRESS CALL PROCEDURE

1. While opening the key cover, push and hold **[DISTRESS]** for 5 sec. until you hear 5 short beeps change to one long beep.
2. Wait for an acknowledgment from a coast station.
 - Channel 16 is automatically selected.
3. Push and hold **[PTT]**, then transmit the appropriate information as listed above.

NOTE

A WARNING STICKER is supplied with the transceiver. To comply with FCC regulations, this sticker must be affixed in such a location as to be readily seen from the operating controls of the radio as in the diagram below. Make sure the chosen location is clean and dry before applying the sticker. (p. 32)

EXAMPLE



RADIO OPERATOR WARNING



Icom requires the radio operator to meet the FCC Requirements for Radio Frequency Exposure. An omnidirectional antenna with gain not greater than 9 dBi must be mounted a minimum of 5 meters (measured from the lowest point of the antenna) vertically above the main deck and

all possible personnel. This is the minimum safe separation distance estimated to meet all RF exposure compliance requirements. This 5 meter distance is based on the FCC Safe Maximum Permissible Exposure (MPE) distance of 3 meters added to the height of an adult (2 meters) and is appropriate for all vessels.

For watercraft without suitable structures, the antenna must be mounted so as to maintain a minimum of 1 meter vertically between the antenna, (measured from the lowest point of the antenna), to the heads of all persons AND all persons must stay outside of the 3 meter MPE radius.

Do not transmit with radio and antenna when persons are within the MPE radius of the antenna, unless such persons (such as driver or radio operator) are shielded from antenna field by a grounded metallic barrier. The MPE Radius is the minimum distance from the antenna axis that person should maintain in order to avoid RF exposure higher than the allowable MPE level set by FCC.

FAILURE TO OBSERVE THESE LIMITS MAY ALLOW THOSE WITHIN THE MPE RADIUS TO EXPERIENCE RF RADIATION ABSORPTION WHICH EXCEEDS THE FCC MAXIMUM PERMISSIBLE EXPOSURE (MPE) LIMIT. IT IS THE RESPONSIBILITY OF THE RADIO OPERATOR TO ENSURE THAT THE MAXIMUM PERMISSIBLE EXPOSURE LIMITS ARE OBSERVED AT ALL TIMES DURING RADIO TRANSMISSION. THE RADIO OPERATOR IS TO ENSURE THAT NO BYSTANDERS COME WITHIN THE RADIUS OF THE MAXIMUM PERMISSIBLE EXPOSURE LIMITS.

Determining MPE Radius

THE MAXIMUM PERMISSIBLE EXPOSURE (MPE) RADIUS HAS BEEN ESTIMATED TO BE A RADIUS OF ABOUT 3M PER OET BULLETIN 65 OF THE FCC. THIS ESTIMATE IS MADE ASSUMING THE MAXIMUM POWER OF THE RADIO AND ANTENNAS WITH A MAXIMUM GAIN OF 9dBi ARE USED FOR A SHIP MOUNTED SYSTEM.

TABLE OF CONTENTS

FOREWORD	i	6 DSC OPERATION	13–27
IMPORTANT	i	■ MMSI code programming	13
EXPLICIT DEFINITIONS	i	■ MMSI code check	13
IN CASE OF EMERGENCY	ii	■ DSC address ID	14
NOTE	ii	■ Position indication	15
RADIO OPERATOR WARNING	iii	■ Distress call	16
TABLE OF CONTENTS	iv	■ Transmitting DSC calls	17
PRECAUTIONS	v	■ Receiving DSC calls	24
1 OPERATING RULES	1	7 SET MODE	28–30
2 PANEL DESCRIPTION	2–4	■ Set mode programming	28
■ Front panel	2	■ Set mode items	29
■ Microphone	3	8 CONNECTIONS AND MAINTENANCE	31–34
■ Function display	4	■ Connections	31
3 BASIC OPERATION	5–9	■ Supplied accessories	32
■ Channel selection	5	■ Antenna	32
■ Receiving and transmitting	7	■ Fuse replacement	32
■ Call channel programming	8	■ Cleaning	32
■ Channel comments	8	■ Mounting the transceiver	33
■ Microphone lock function	9	■ Optional MB-92 attachment	33
■ Display backlighting	9	■ Optional MB-69 installation	34
■ AquaQuake water draining function	9	9 TROUBLESHOOTING	35
4 SCAN OPERATION	10–11	10 CHANNEL LIST	36
■ Scan types	10	11 SPECIFICATIONS AND OPTIONS	37–38
■ Setting TAG channels	11	■ Specifications	37
■ Starting a scan	11	■ Options	38
5 DUALWATCH/TRI-WATCH	12	12 TEMPLATE	39
■ Description	12		
■ Operation	12		

PRECAUTIONS

⚠ WARNING! NEVER connect the transceiver to an AC outlet. This may pose a fire hazard or result in an electric shock.

CAUTION: Changes or modifications to this device, not expressly approved by Icom Inc., could void your authority to operate this device under FCC regulations.

NEVER connect the transceiver to a power source of more than 16 V DC or use reverse polarity. This will ruin the transceiver.

NEVER cut the DC power cable between the DC plug and fuse holder. If an incorrect connection is made after cutting, the transceiver may be damaged.

NEVER place the transceiver where normal operation of the vessel may be hindered or where it could cause bodily injury.

KEEP the transceiver at least 3.3 ft (1 m) away from the ship's navigation compass.

DO NOT use or place the transceiver in areas with temperatures below -4°F (-20°C) or above $+140^{\circ}\text{F}$ ($+60^{\circ}\text{C}$) or, in areas subject to direct sunlight, such as the dashboard.

AVOID the use of chemical agents such as benzine or alcohol when cleaning, as they may damage the transceiver surfaces.

BE CAREFUL! The transceiver rear panel will become hot when operating continuously for long periods. Place the transceiver in a secure place to avoid inadvertent use by children.

BE CAREFUL! The transceiver (except cables) and hand microphone employ waterproof construction, which corresponds to IPX7 of the international standard IEC 60529 (2001). However, once the transceiver has been dropped, waterproofing cannot be guaranteed due to the fact that the case may be cracked, or the waterproof seal damaged, etc.

◇ PRIORITIES

- Read all rules and regulations pertaining to priorities and keep an up-to-date copy handy. Safety and distress calls take priority over all others.
- You must monitor Channel 16 when you are not operating on another channel.
- False or fraudulent distress signals are prohibited and punishable by law.

◇ PRIVACY

- Information overheard but not intended for you cannot lawfully be used in any way.
- Indecent or profane language is prohibited.

◇ RADIO LICENSES

(1) SHIP STATION LICENSE

You must have a current radio station license before using the transceiver. It is unlawful to operate a ship station which is not licensed.

Inquire through your dealer or the appropriate government agency for a Ship-Radiotelephone license application. This government-issued license states the call sign which is your craft's identification for radio purposes.

(2) OPERATOR'S LICENSE

A Restricted Radiotelephone Operator Permit is the license most often held by small vessel radio operators when a radio is not required for safety purposes.

The Restricted Radiotelephone Operator Permit must be posted or kept with the operator. Only a licensed radio operator may operate a transceiver.

However, non-licensed individuals may talk over a transceiver if a licensed operator starts, supervises, ends the call and makes the necessary log entries.

Keep a copy of the current government rules and regulations handy.

Radio license for boaters (U.S.A. only)

The Telecommunications Act of 1996 permits recreational boaters to have and use a VHF marine radio, EPIRB, and marine radar without having an FCC ship station license. Boaters traveling on international voyages, having an HF single sideband radiotelephone or marine satellite terminal, or required to carry a marine radio under any other regulation must still carry an FCC ship station license. For further information, see the FCC Ship Radio Stations Fact Sheet.

■ Front panel

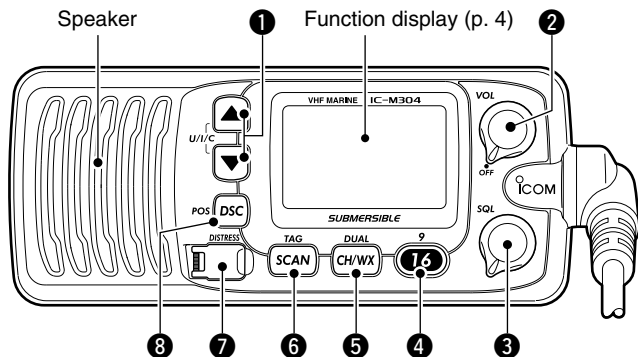

① CHANNEL UP/DOWN KEYS [▲]/[▼]•[U/I/C]

- ➔ Selects the operating channels, Set mode settings, etc. (pgs. 5, 6, 28)
- ➔ While pushing and holding [SCAN], push to adjust the brightness of the LCD and key backlight. (p. 9)
- ➔ Selects one of three channel groups in sequence when both keys are pushed. (p. 6)
 - U.S.A., International and Canadian channels are available.
- ➔ While turning power ON, push and hold both keys to activate the AquaQuake function. (p. 9)

② POWER/VOLUME CONTROL [VOL] (p. 7)

Rotate to turn the transceiver power ON and OFF and adjusts the audio level.

③ SQUELCH CONTROL [SQL] (p. 7)

Rotate to set the squelch threshold level.

④ CHANNEL 16/CALL CHANNEL KEY [16•9]

- ➔ Push to select Channel 16. (p. 5)
- ➔ Push and hold for 1 sec. to select call channel. (p. 5)
 - "CALL" appears when the call channel is selected.
- ➔ Push and hold for 3 sec. to enter call channel programming condition when the call channel is selected. (p. 8)
- ➔ While pushing and holding [CH/WX], push to enter the channel comments programming condition. (p. 8)
- ➔ Push to move the cursor forward. (p. 8)
- ➔ While turning power ON, push to enter Set mode. (p. 28)

⑤ CHANNEL/WEATHER CHANNEL KEY [CH/WX•DUAL]

- ➔ Selects and toggles the regular channel and weather channel when pushed momentarily. (p. 6)
- ➔ Push and hold for 1 sec. to start Dualwatch or Tri-watch. (p. 12)
- ➔ Push to stop Dualwatch or Tri-watch when either is activated. (p. 12)
- ➔ Push to move the cursor backward. (p. 8)

- 6 SCAN KEY [SCAN•TAG]** (p. 11)

 - Push to start or stop the Normal or Priority scan.
 - Push and hold for 1 sec. to set or clear the displayed channel as a TAG (scanned) channel.
 - The favorite channels are set by the TAG channel setting.
 - While pushing and holding **[HI/LO]** on the microphone, push for 3 sec. to clear all TAG channels in the selected channel group.
 - Repeat above procedure to set all TAG channels.
- 7 DISTRESS KEY [DISTRESS]** (p. 16)

Push and hold for 5 sec. to transmit a Distress call.
- 8 DSC/POSITION KEY [DSC•POS]**

 - Push to enter DSC menu. (p. 13)
 - Push and hold for 1 sec. to show the current position from a GPS receiver. (p. 15)

■ Microphone

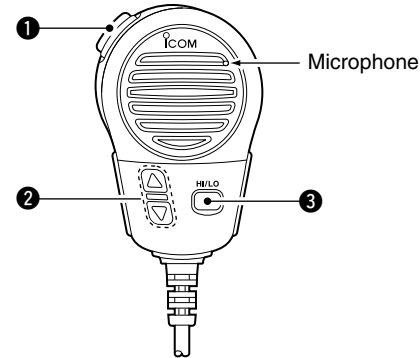

- 1 PTT SWITCH [PTT]**

Push and hold to transmit; release to receive. (p. 7)
- 2 CHANNEL UP/DOWN KEYS [▲]/[▼]**

 - Push either key to change the operating channel, Set mode settings, etc. (pgs. 5, 6, 28)
 - When the Favorite channel function is turned ON, push either key to select the favorite channels in the selected channel group in sequence. (p. 30)
- 3 TRANSMIT POWER KEY [HI/LO]**

 - Push to toggle the power high and low. (p. 7)
 - Some channels are set to low power only.
 - While pushing and holding **[HI/LO]**, turn power ON to toggle the Microphone Lock function ON and OFF. (p. 9)

2 PANEL DESCRIPTION

■ Function display

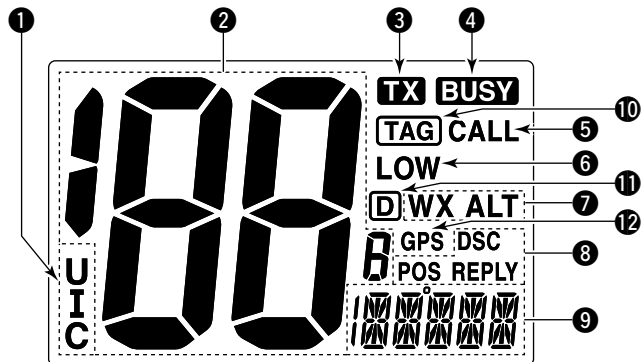

- 1 CHANNEL GROUP INDICATOR** (p. 6)
Indicates whether a U.S.A. “U,” International “I” or Canadian “C” channel is in use.
- 2 CHANNEL NUMBER READOUT**
 - ➔ Indicates the selected operating channel number.
 - Refer to **CHANNEL LIST**. (p. 36)
 - ➔ In Set mode, indicates the selected condition. (p. 28)
- 3 TRANSMIT INDICATOR** (p. 7)
Appears while transmitting.
- 4 BUSY INDICATOR** (p. 7)
Appears when receiving a signal or when the squelch opens.

- 5 CALL CHANNEL INDICATOR** (p. 5)
Appears when the call channel is selected.
- 6 LOW POWER INDICATOR** (p. 7)
Appears when low power is selected.
- 7 WEATHER CHANNEL INDICATOR** (pgs. 6, 29)
 - ➔ “WX” appears when a weather channel is selected.
 - ➔ “WX ALT” appears when the Weather alert function is in use; blinks when an alert tone is received.
- 8 DSC INDICATORS**
 - ➔ “DSC” appears when a DSC call is received. (p. 24)
 - ➔ “POS REPLY” appears when a Position Reply call or Position Report Reply call is received. (p. 27)
- 9 CHANNEL COMMENT INDICATOR**
 - ➔ Channel comment appears if programmed. (p. 8)
 - ➔ “LOW BATTERY” scrolls when the battery voltage drops to approx. 10.8 V DC or below.
 - ➔ “SC” blinks during Priority scan; “SCAN” blinks during Normal scan. (p. 11)
 - ➔ “DW” blinks during Dualwatch; “TW” blinks during Tri-watch. (p. 12)
- 10 TAG CHANNEL INDICATOR** (p. 11)
Appears when a TAG channel is selected.
- 11 DUPLEX INDICATOR** (p. 6)
Appears when a duplex channel is selected.
- 12 GPS INDICATOR**
 - ➔ Appears while valid position data is received.
 - ➔ Blinks when invalid position data is received.
 - ➔ Disappears when no GPS receiver is connected.

■ Channel selection

◇ Channel 16

Channel 16 is the distress and safety channel. It is used for establishing initial contact with a station and for emergency communications. Channel 16 is monitored during both Dual-watch and Tri-watch. While standing by, you must monitor Channel 16.

- Push [**16**] momentarily to select Channel 16.
- Push [**CH/WX**] to return to the condition before selecting Channel 16, or push [**▲**] or [**▼**] to select operating channel.

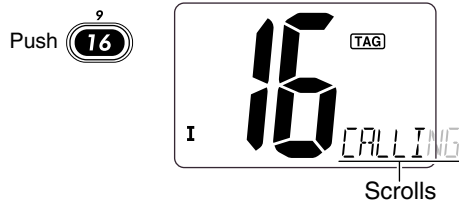

Convenient!

When the Favorite channel function is turned ON (p. 30), [**▲**]/[**▼**] keys on the microphone select the favorite channels in the selected channel group in sequence when pushed.

- The favorite channels are set by the TAG channel setting. (p. 11)

◇ Channel 9 (Call channel)

Each regular channel group has a separate leisure-use call channel. The call channel is monitored during Tri-watch. The call channels can be programmed (p. 8) and are used to store your most often used channels in each channel group for quick recall.

- Push and hold [**9**] (**16**) for 1 sec. to select the call channel of the selected channel group.
 - “**CALL**” and call channel number appear.
 - Each channel group may have an independent call channel after programming a call channel. (p. 8)
- Push [**CH/WX**] to return to the condition before selecting call channel, or push [**▲**] or [**▼**] to select a channel.

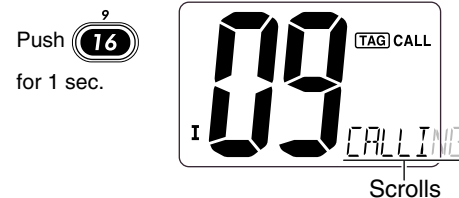

3 BASIC OPERATION

◆ U.S.A., Canadian and international channels

The IC-M304 is pre-programmed with 59 U.S.A., 59 international and 63 Canadian channels. These channel groups may be specified for the operating area.

- ① Push **[CH/WX]** to select a regular channel.
 - If a weather channel appears, push **[CH/WX]** again.
- ② Push **[U/I/C]** (both **[▲]** and **[▼]**) on the transceiver to change the channel group, if necessary.
 - U.S.A., International and Canadian channel groups can be selected in sequence.
- ③ Push **[▲]** or **[▼]** to select a channel.
 - “**□**” appears for duplex channels.

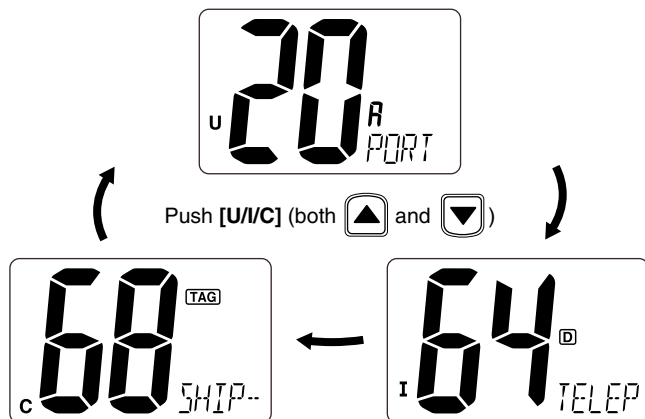

◆ Weather channels

The IC-M304 has 10 pre-programmed weather channels. These are used for monitoring broadcasts from NOAA (National Oceanic and Atmospheric Administration.)

The transceiver can automatically detect a weather alert tone on the selected weather channel while receiving the channel or during scanning. (p. 29)

- ① Push **[CH/WX]** once or twice to select a weather channel.
 - “**WX**” appears when a weather channel is selected.
 - “**WX ALT**” appears when the Weather alert function is in use. (p. 29)
- ② Push **[▲]** or **[▼]** to select a channel.

Push **[CH/WX]** once or twice

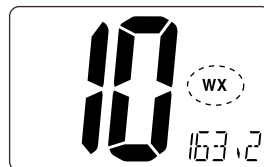

When Weather alert is OFF.

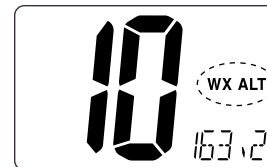

When Weather alert is ON.

■ Receiving and transmitting

/// **CAUTION:** Transmitting without an antenna will damage the transceiver.

- ① Rotate **[VOL]** to turn power ON.
- ② Set the audio and squelch levels.
 - ➔ Rotate **[SQL]** fully counterclockwise in advance.
 - ➔ Rotate **[VOL]** to adjust the audio output level.
 - ➔ Rotate **[SQL]** clockwise until the noise disappears.
- ③ Push **[U/I/C]** (both **[▲]** and **[▼]**) on the transceiver several times to select the desired channel group. (p. 6)
- ④ Push **[▲]** or **[▼]** to select a channel. (p. 5)
 - When receiving a signal, “**BUSY**” appears and audio is emitted from the speaker.
 - Further adjustment of **[VOL]** may be necessary.
- ⑤ Push **[HI/LO]** on the microphone to select the output power if necessary.
 - “**LOW**” appears when low power is selected.
 - Choose low power for short range communications, choose high power for longer distance communications.
 - Some channels are for low power only.
- ⑥ Push and hold **[PTT]** to transmit, then speak into the microphone.
 - “**TX**” appears.
 - Channel 70 cannot be used for transmission other than DSC.
- ⑦ Release **[PTT]** to receive.

/// Simplex channels, 3, 21, 23, 61, 64, 81, 82 and 83 **CANNOT** be lawfully used by the general public in U.S.A. waters.

/// **IMPORTANT:** To maximize the readability of your transmitted signal, pause a few sec. after pushing **[PTT]**, hold the microphone 2 to 4 inches (5 to 10 cm) from your mouth and speak into the microphone at a normal voice level.

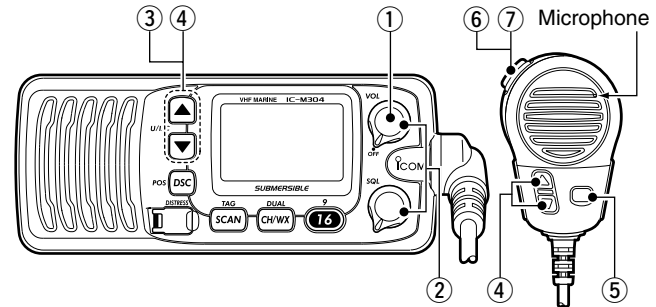

✓ **NOTE for TOT (Time-out Timer) function**

The TOT function inhibits continuous transmission over a pre-set time period after the transmission starts.

3 BASIC OPERATION

■ Call channel programming

Call channel is used to select Channel 9 (default), however, you can program the call channel with your most often-used channel in each channel group for quick recall.

- ① Push **[U/I/C]** (both **[▲]** and **[▼]**) on the transceiver several times to select the desired channel group (U.S.A., International or Canada) to be programmed.
- ② Push and hold **[9] (16)** for 1 sec. to select the call channel of the selected channel group.
 - “CALL” and call channel number appear.
- ③ Push and hold **[9] (16)** again for 3 sec. (until a long beep changes to 2 short beeps) to enter call channel programming condition.
 - Channel number starts blinking.
- ④ Push **[▲]** or **[▼]** to select the desired channel.
- ⑤ Push **[16]** to program the displayed channel as the call channel.
 - Push **[CH/WX]** to cancel.
 - The channel number stops blinking.

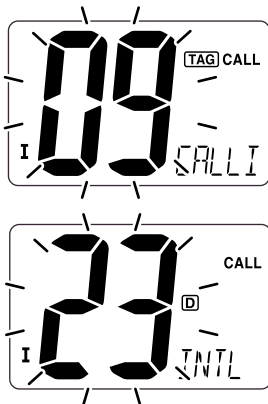

■ Channel comments

Memory channels can be labeled with a unique alphanumeric ID of up to 10 characters each.

More than 6 characters comment scrolls automatically at the channel comment indicator after the channel selection.

Capital letters, small letters (except f, j, k, p, s, v, x, z), 0 to 9, some symbols (= * + - . /) and space can be used.

- ① Select the desired channel.
 - Cancel Dualwatch, Tri-watch or Scan in advance.
 - ② While pushing **[CH/WX]**, push **[16]** to edit the channel comment.
 - A cursor and the first character start blinking alternately.
- 
- The image shows a digital display with '71' and 'SPRERS' scrolling below it. The 'S' is under a cursor. The display has 'I' and 'SPRERS' indicators on the sides.
- ③ Pushing **[▲]** or **[▼]** to select the desired character.
 - Push **[16]** or **[CH/WX]** to move the cursor forward or backward, respectively.
 - ④ Repeat step ③ to input all characters.
 - ⑤ Push **[DSC]** to input and set the comment.
 - Push **[SCAN]** to cancel.
 - The cursor and the character stop blinking.
 - ⑥ Repeat steps ① to ⑤ to program other channel comments, if desired.

■ Microphone lock function

The microphone lock function electrically locks [▲] and [▼] keys on the supplied microphone. This prevents accidental channel changes and function access.

- ➔ While pushing and holding [HI/LO] on the microphone, turn power ON to toggle the Microphone lock function ON and OFF.

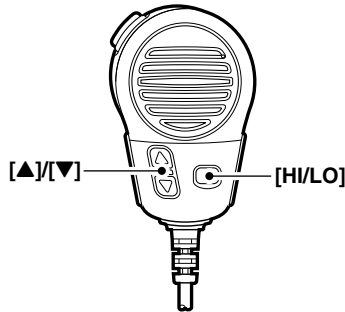

■ Display backlighting

The function display and keys can be backlit for better visibility under low light conditions.

- ➔ While pushing and holding [SCAN], push [▲] or [▼] to adjust the brightness of the LCD and key backlight.
 - The backlight is selectable in 3 levels and OFF.

■ AquaQuake water draining function

The IC-M304 uses a new technology to clear water away from the speaker grill: AquaQuake. AquaQuake helps drain water away from the speaker housing (water that might otherwise muffle the sound coming from the speaker). The IC-M304 emits a vibrating noise when this function is being used.

- ➔ While pushing and holding [▲] and [▼], turn power ON.
 - A low beep tone sounds while [▲] or [▼] keys are held to drain water, regardless of [VOL] control setting.
 - The transceiver never accepts a key operation while the AquaQuake function is activated.
 - "AQUA QUAKE" scrolls at the channel comment indicator.

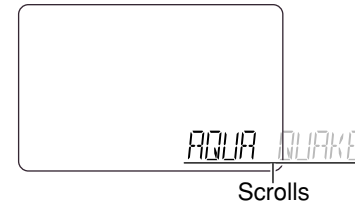

■ Scan types

Scanning is an efficient way to locate signals quickly over a wide frequency range. The transceiver has Priority scan and Normal scan.

When the Weather alert function is turned ON, the previously selected (last used) weather channel is also checked while scanning. (p. 29)

PRIORITY SCAN

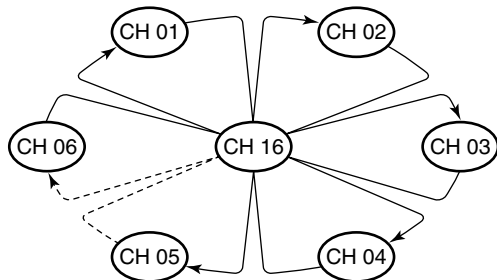

Priority scan searches through all TAG channels in sequence while monitoring Channel 16. When a signal is detected on Channel 16, scan pauses until the signal disappears; when a signal is detected on a channel other than Channel 16, scan becomes Dualwatch until the signal disappears.

Set the TAG channels (scanned channels) before scanning. Clear the TAG channels which inconveniently stop scanning, such as those for digital communication use. (Refer to the right page for details.)

∕∕ Choose Priority or Normal scan in Set mode. (p. 29)

NORMAL SCAN

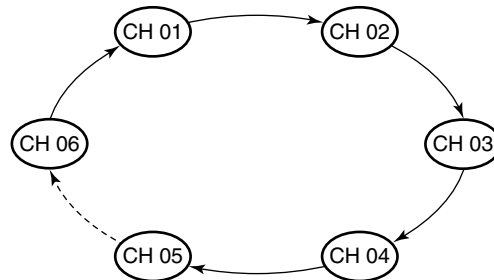

Normal scan, like priority scan, searches through all TAG channels in sequence. However, unlike priority scan, Channel 16 is not checked unless Channel 16 is set as a TAG channel.

■ Setting TAG channels

For more efficient scanning, add desired channels as TAG channels or clear the TAG for unwanted channels.

Channels that are not tagged will be skipped during scanning. TAG channels can be assigned to each channel group (U.S.A., International and Canada) independently.

- ① Push **[U/I/C]** (both **[▲]** and **[▼]**) several times to select the desired channel group.
- ② Select the desired channel to be set as a TAG channel.
- ③ Push and hold **[TAG]** (SCAN) for 1 sec. to set the displayed channel as a TAG channel.
 - “TAG” appears in the display.
- ④ To cancel the TAG channel setting, repeat step ③.
 - “TAG” disappears.

✓ Clearing (or setting) all tagged channels

While pushing and holding **[HI/LO]** on the microphone, push **[TAG]** (SCAN) for 3 sec. (until a long beep changes to 2 short beeps) to clear all TAG channels in the selected channel group.

- Repeat above procedure to set all TAG channels.

■ Starting a scan

Set scan type (Priority or Normal scan) and scan resume timer in advance using Set mode. (p. 29)

- ① Push **[U/I/C]** (both **[▲]** and **[▼]**) several times to select the desired channel group, if desired.
- ② Set TAG channels as described at left.
- ③ Make sure the squelch is closed to start a scan.
- ④ Push **[SCAN]** to start Priority or Normal scan.
 - “SC” blinks during Priority scan; “SCAN” blinks during Normal scan.
 - When a signal is detected, scan pauses until the signal disappears or resumes after pausing 5 sec. according to Set mode setting. (Channel 16 is still monitored during Priority scan.)
 - Push **[▲]** or **[▼]** to check the scanning TAG channels, to change the scanning direction or resume the scan manually.
 - A beep tone sounds and “SC 16” blinks at the channel comment indicator when a signal is received on Channel 16 during Priority scan.
- ⑤ To stop the scan, push **[SCAN]**.

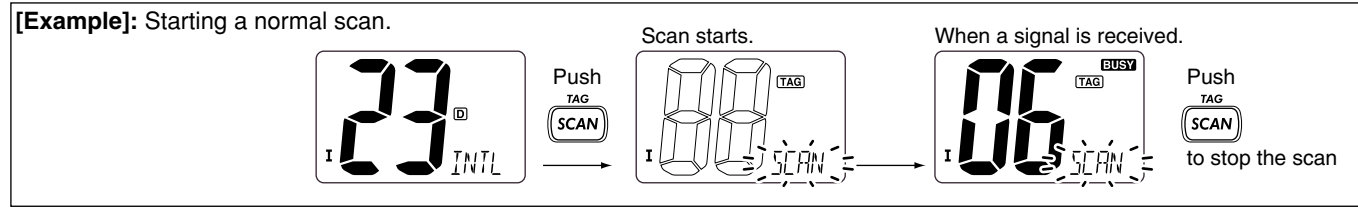

■ Description

Dualwatch monitors Channel 16 while you are receiving on another channel; Tri-watch monitors Channel 16 and the call channel while receiving another channel. Dualwatch/Tri-watch are convenient for monitor Channel 16 when you are operating on another channel.

DUALWATCH/TRI-WATCH SIMULATION

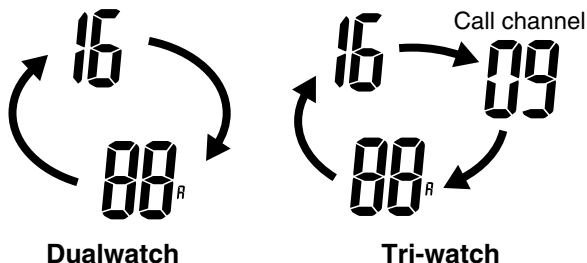

- If a signal is received on Channel 16, Dualwatch/Tri-watch pauses on Channel 16 until the signal disappears.
- If a signal is received on the call channel during Tri-watch, Tri-watch becomes Dualwatch until the signal disappears.
- To transmit on the selected channel during Dualwatch/Tri-watch, push and hold [PTT].

■ Operation

- ① Select Dualwatch or Tri-watch in Set mode. (p. 29)
- ② Select the desired channel.
- ③ Push and hold [DUAL] (CH/WX) for 1 sec. to start Dualwatch or Tri-watch.
 - “TW” blinks during Dualwatch; “TW” blinks during Tri-watch.
 - A beep tone sounds when a signal is received on Channel 16.
- ④ To cancel Dualwatch or Tri-watch, push [DUAL] (CH/WX).

[Example]: Operating Tri-watch on INT Channel 25

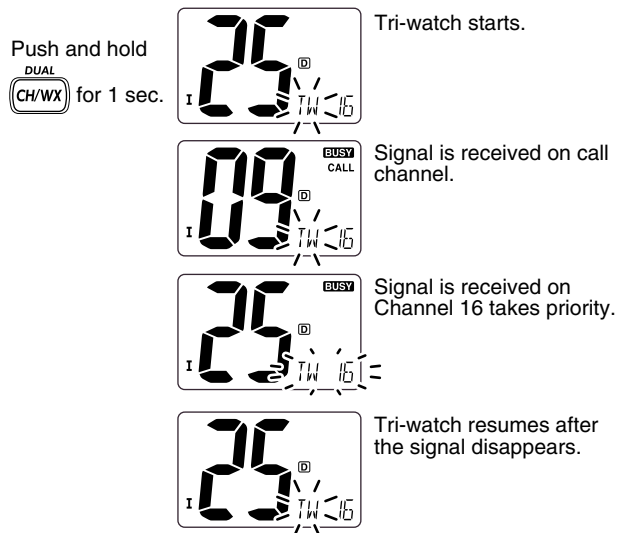

■ MMSI code programming

The 9-digit MMSI (Maritime Mobile Service Identity: DSC self ID) code can be programmed at power ON.

⚡ **This code programming can be performed only twice.**

- ① Turn power OFF.
- ② While pushing and holding **[DSC]**, turn power ON to enter MMSI code programming condition.
- ③ After the display appears, release **[DSC]**.
 - A cursor starts blinking.

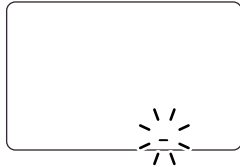

- ④ Edit the specified MMSI code by pushing **[▲]** or **[▼]**.
 - Push **[←]** or **[CH/WX]** to move the cursor forward or backward, respectively.
- ⑤ Input 9-digit code, then push **[DSC]** to set the code.
 - Returns to the normal operation.

■ MMSI code check

The 9-digit MMSI (DSC self ID) code can be checked.

- ① Push **[DSC]** to enter the DSC menu.
- ② Push **[▲]** or **[▼]** to select “MMSI” and push **[DSC]**.



- ③ Check the 9-digit MMSI (DSC self ID) code.
 - The MMSI code is displayed and scrolls at the channel comment indicator.



MMSI (DSC self ID) code scrolls

- ④ Push **[DSC]** to return to the normal operation.

■ DSC address ID

A total of 30 DSC address IDs (9-digit) can be programmed and named with up to 5 characters.

◇ Programming address ID

- ① Push **[DSC]** to enter the DSC menu.
- ② Push **[▲]** or **[▼]** to select “ADDRESS,” and push **[DSC]**.

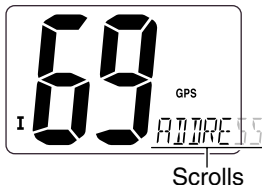

- ③ Push **[▲]** or **[▼]** to select “ADD,” and push **[DSC]**.



- ④ Push **[▲]** or **[▼]** to input 9-digit of the appropriate address ID.

- Push **[16]** or **[CH/WX]** to move the cursor forward or backward, respectively.
- Push **[SCAN]** to cancel and exit the condition.

/// 1st digit '0' is fixed for a group ID. When you input 1st digit '0' and other 8 digits, the ID is automatically registered as a group ID.

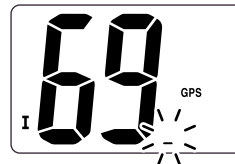

- ⑤ After inputting 9-digit ID, push **[DSC]** to input 5 characters ID name using **[▲]** or **[▼]**.

- Push **[16]** or **[CH/WX]** to move the cursor forward or backward, respectively.
- Push **[SCAN]** to cancel and exit the condition.

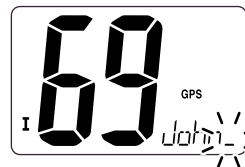

- ⑥ Push **[DSC]** to program and exit the DSC menu.

◆ Deleting address ID

- ① Push [DSC] to enter the DSC menu.
- ② Push [▲] or [▼] to select "ADDRESS" and push [DSC].

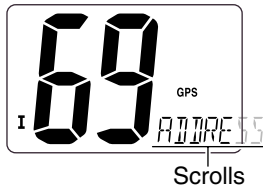

- ③ Push [▲] or [▼] to select "DEL", then push [DSC].
 - When no address ID is programmed, "NO ID" is displayed.



- ④ Push [▲] or [▼] to select the desired ID name for deleting and push [DSC].
 - "READY" appears.



- ⑤ Push [DSC] to delete the address ID and exit the DSC menu.

■ Position indication

When a GPS receiver (NMEA0183 ver. 2.0 or 3.01) is connected, the transceiver indicates the current position data in seconds of accuracy.

A NMEA0183 ver. 2.0 or 3.01 (sentence formatters RMC, GGA, GNS, GLL) compatible GPS receiver is required. Ask your dealer about suitable GPS receivers.

- Push and hold [POS] (DSC) for 1 sec. to display the current position.
 - 'Latitude' and 'Longitude' scroll in sequence at the channel comment indicator.
 - "NO POSITION" scrolls when no GPS is connected.

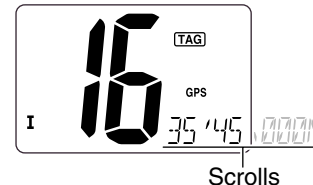

- When the connecting GPS receiver is compatible with several sentence formatters, the order of input precedence is 'RMC,' 'GGA,' 'GNS' and 'GLL.'
- "GPS" blinks when the GPS data is invalid.

6 DSC OPERATION

■ Distress call

A Distress call should be transmitted if, in the opinion of the Master, the ship or a person is in distress and requires immediate assistance.

NEVER USE THE DISTRESS CALL WHEN YOUR SHIP OR A PERSON IS NOT IN AN EMERGENCY. A DISTRESS CALL CAN BE USED ONLY WHEN IMMEDIATE HELP IS NEEDED.

- ① Confirm no Distress call is being received.
- ② While opening the key cover, push **[DISTRESS]** for 5 sec. to transmit the Distress call.
 - Emergency channel (Channel 70) is automatically selected and the Distress call is transmitted.



- ③ After transmitting the call, the transceiver waits for an acknowledgment call on Channel 70.
 - The Distress call is automatically transmitted every 3.5 to 4.5 minutes.
 - “*DSC REPEAT*” scrolls at the channel comment indicator.

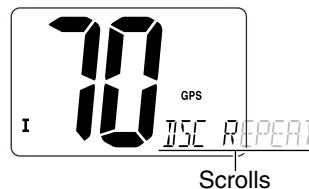

- ④ After receiving the acknowledgment, reply using the microphone.
 - “*REV DISTRESS ACK*” scrolls at the channel comment indicator.

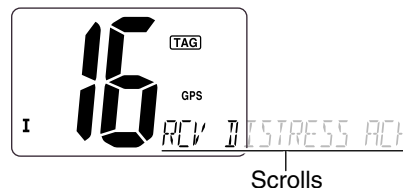

- A distress alert contains;
 - Kinds of distress : Undesignated distress
 - Position data : GPS position data held for 23.5 hrs. or until the power is turned OFF.
- The Distress call is repeated every 3.5–4.5 min., until receiving an ‘acknowledgement.’
- Push and hold **[DISTRESS]** for 5 sec. to transmit a renewed Distress call, if desired.
- Push any key except **[DISTRESS]** to cancel the ‘Call repeat’ mode.

■ Transmitting DSC calls

/// To ensure correct operation of the DSC function, please make sure you set the squelch correctly. (p. 7)

◇ Transmitting Individual call

The Individual call function allows you to transmit a DSC signal to a specific ship only.

- ① Push **[DSC]** to enter the DSC menu.
 - “*INDIVIDUAL*” scrolls at the channel comment indicator.

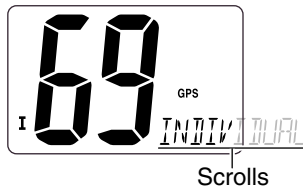

- ② Push **[DSC]** to select the desired pre-programmed individual address using **[▲]** or **[▼]**, then push **[DSC]**.
 - The ID code for the individual call must be set in advance. (p. 14)



- ③ Push **[▲]** or **[▼]** to select a desired intership channel, push **[DSC]**.
 - Intership channels are already preset into the transceiver in recommended order.
 - Channel 70 is selected and “*READY*” appears after pushing **[DSC]**.

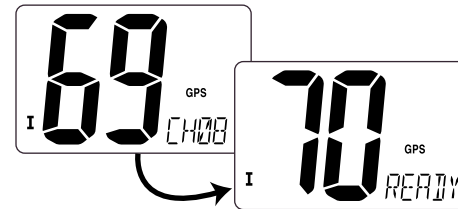

- ④ Push **[DSC]** to transmit the Individual call.
 - If Channel 70 is busy, the transceiver stands by until the channel becomes clear.
 - Routine category only is available.

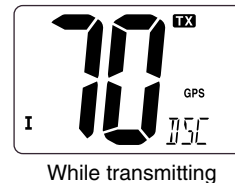

While transmitting



When Ch 70 is busy.

6 DSC OPERATION

- ⑤ After transmitting the Individual call, standby on Channel 70 until an acknowledgement is received.

- “*WAIT ACK*” scrolls at the channel comment indicator.

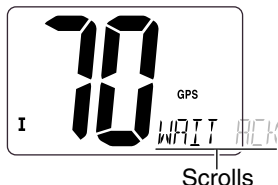

- ⑥ When the acknowledgement ‘Able to comply’ is received, the specified channel (in step ③) is selected with beeps automatically. Or, when the acknowledgement ‘Unable to comply’ is received, the display returns to the operated channel (before entering the DSC menu) with beeps.

- “*REV ABLE ACK*” or “*REV UNABLE ACK*” scrolls at the channel comment indicator.

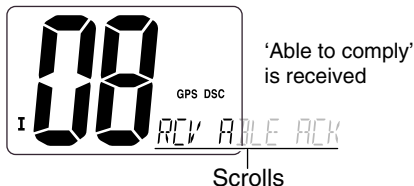

- ⑦ Push and hold [PTT] to communicate your message to the responding ship when ‘Able to comply’ is received.

◇ Transmitting Individual acknowledgement

When receiving an Individual call, you can transmit an acknowledgement (‘Able to comply’ or ‘Unable to comply’) by using the on screen prompts (see page 25 for details). You can also send an acknowledgement through the menu system as follows.

- ① Push [DSC] to enter the DSC menu.
- ② Push [▲] or [▼] to select “*INDW ACK*” and push [DSC].
 - “*INDW ACK*” item appears after an Individual call is received.
 - “*INDW ACK*” item disappears if another call is received after the Individual call.
 - The Individual acknowledgement can be transmitted to the last received individual call only.

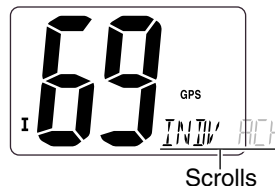

- ③ Push [▲] or [▼] to select the acknowledgement “*ABLE*” or “*UNABLE*”.

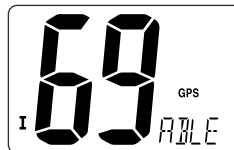

- ④ Push **[DSC]** to enter the standby condition for Individual acknowledgement call.
 - “READY” appears at the channel comment indicator.



- ⑤ Push **[DSC]** to transmit the acknowledgement to the selected station.



- ⑥ After the Individual acknowledgement has been transmitted, the display changes to the channel specified by the calling station automatically when “ABLE” is selected.

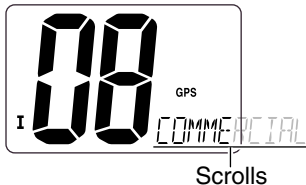

◇ Transmitting Group call

The Group call function allows you to transmit a DSC signal to a specific group only.

- ① Push **[DSC]** to enter the DSC menu.
- ② Push **[▲]** or **[▼]** to select “GROUP,” and push **[DSC]**.



- ③ Push **[▲]** or **[▼]** to select the desired pre-programmed group address, and push **[DSC]**.
 - The ID code for the group call must be set in advance. (p. 14)



6 DSC OPERATION

- ④ Push [**▲**] or [**▼**] to select the desired intership channel, and push [**DSC**].

- Channel 70 is selected and “READY” appears.

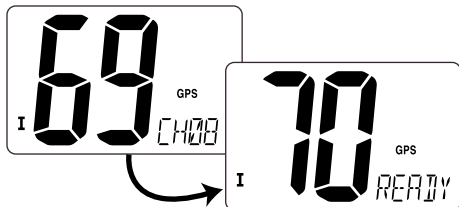

- ⑤ Push [**DSC**] to transmit the Group call.

- If Channel 70 is busy, the transceiver stands by until the channel becomes clear.
- Routine category only is available.



While transmitting

- ⑥ After the Group call has been transmitted, the display changes to the previously specified channel.

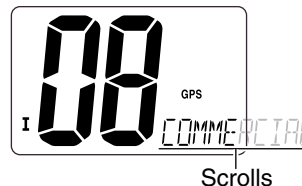

- ⑦ Push and hold [**PTT**] to communicate your message to the responding ship.

◇ Transmitting All Ships call

Large ships use Channel 70 as their 'listening channel.' When you want to announce a message to these ships, use the 'All Ships call' function.

- ① Push **[DSC]** to enter the DSC menu.
- ② Push **[▲]** or **[▼]** to select "ALL SHIPS."

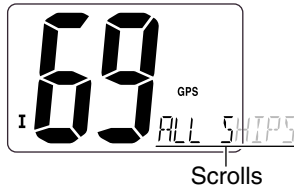

- ③ Push **[DSC]** to enter the standby condition for All Ships call.
 - Channel 70 is selected and "READY" appears.



- ④ Push **[DSC]** to transmit the All Ships call.
 - Routine category only is available.
 - Low power is selected.

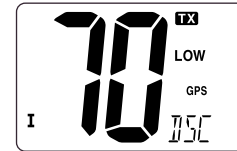

While transmitting

- ⑤ After the All Ships call has been transmitted, the display changes to Channel 16 automatically.



6 DSC OPERATION

◇ Transmitting Position Request call

Transmit a Position Request call when you want to know a specified ship's current position, etc.

- ① Push **[DSC]** to enter the DSC menu.
- ② Push **[▲]** or **[▼]** to select "POS REQUEST," then push **[DSC]**.



Scrolls

- ③ Push **[▲]** or **[▼]** to select the desired pre-programmed individual address.
 - The ID code for position request must be set in advance. (p. 14)



- ④ Push **[DSC]** to enter the standby condition for Position Request call.
 - Channel 70 is selected and "READY" appears.



- ⑤ Push **[DSC]** to transmit the Position Request call.



While transmitting

- ⑥ After the Position Request call has been transmitted, the following indication is displayed.
 - "WAIT ACK" scrolls at the channel comment indicator.

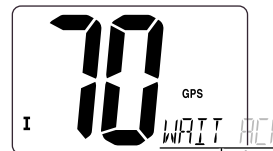

Scrolls

- ⑦ Push any key to exit the condition and return to the normal operation.

◇ Transmitting Position Report call

Transmit a Position Report call when you want to announce your own position to a specific ship and to get an answer, etc.

- ① Push **[DSC]** to enter the DSC menu.
- ② Push **[▲]** or **[▼]** to select “POS REPORT,” and push **[DSC]**.

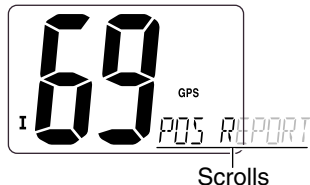

- ③ Push **[▲]** or **[▼]** to select the desired pre-programmed individual address.
 - The ID code for the position report call can be set in advance. (p. 14)



- ④ Push **[DSC]** to enter the standby condition for Position Report call.
 - Channel 70 is selected and “READY” appears.



- ⑤ Push **[DSC]** to transmit the Position Report call.



While transmitting

- ⑥ After the Position Report call has been transmitted, stand by on Channel 70 until an acknowledgement is received.
 - “WAIT ACK” scrolls at the channel comment indicator.

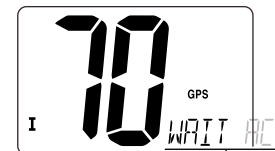

Scrolls

- ⑦ Push any key to exit the condition and return to the normal operation.

■ Receiving DSC calls

◇ Receiving a Distress call

While monitoring Channel 70 and a Distress call is received:

- The emergency alarm sounds.
 - Push any key to stop the alarm.
- “DSC” appears and “REV DISTRESS” scrolls at the channel comment indicator, then Channel 16 is automatically selected.
- Continue monitoring Channel 16 as a coast station may require assistance.

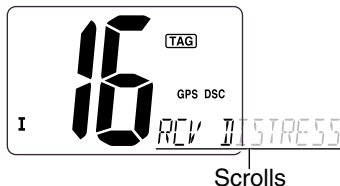

◇ Receiving a Distress acknowledgement

While monitoring Channel 70 and a Distress acknowledgement to other ship is received:

- The emergency alarm sounds.
 - Push any key to stop the alarm.
- “DSC” appears and “REV DISTRESS ACK” scrolls at the channel comment indicator, then Channel 16 is automatically selected.



◇ Receiving a Distress Relay call

While monitoring Channel 70 and a Distress Relay acknowledgement is received:

- The emergency alarm sounds.
 - Push any key to stop the alarm.
- “DSC” appears and “REV RELAY” scrolls at the channel comment indicator, then Channel 16 is automatically selected.

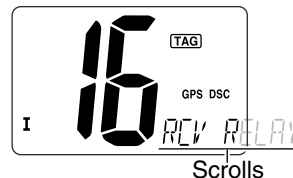

◇ Receiving an Individual call

While monitoring Channel 70 and an Individual call is received:

- The emergency alarm or beeps sound depending on the received category.
- “DSC” appears and “REV INDIVIDUAL” scrolls at the channel comment indicator.
- Push any key to stop beep, then push [DSC] to reply the call and select the channel specified by the calling station for voice communication (depending on your replying condition see p. 18 for individual acknowledgement call procedure for details.); push any other key to ignore the Individual call.

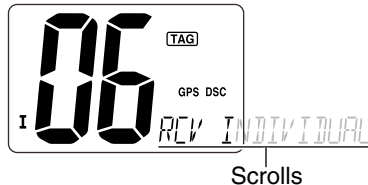

◇ Receiving a Group call

While monitoring Channel 70 and a Group call is received:

- The emergency alarm or beeps sound depending on the received category.
- “DSC” appears and “REV GROUP” scrolls at the channel comment indicator.
- Push any key to stop beep, then push [DSC] to select the channel specified by the calling station for voice communication; push any other key to ignore the Group call.



6 DSC OPERATION

◇ Receiving an All Ships call

While monitoring Channel 70 and an All Ships call is received:

- The emergency alarm sounds when the category is 'Distress' or 'Urgency'; 2 beeps sound for other categories.
- "DSC" appears and "REV ALL SHIPS" scrolls at the channel comment indicator.
- Push any key to stop beep, then push [DSC] to monitor channel 16 for an announcement from the calling vessel, push any other key to ignore the call.

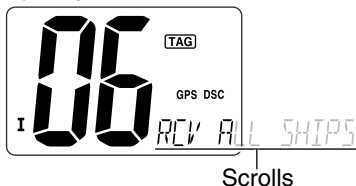

◇ Receiving a Geographical Area call

While monitoring Channel 70 and a Geographical Area call (for the area you are in) is received:

- The emergency alarm or beeps sound depending on the received category.
- "DSC" appears and "REV GEOGRAPHICAL" scrolls at the channel comment indicator.
- Push any key to stop the beep, then push [DSC] to change to the channel specified by the calling station for voice communication; push any other key to ignore the Geographical Area call.
- Monitor the selected channel for an announcement from the calling station.



/// When no GPS receiver is connected or if there is a problem with the connected receiver, all Geographical Area calls are received, regardless of your position.

◇ **Receiving a Position Request call**

While monitoring Channel 70 and a Position Request call is received:

- “DSC” appears and “*RCV POS REQUEST*” scrolls at the channel comment indicator.
- Push any key to stop the beep, then push [DSC] to reply to the call; push any other key to ignore the call.

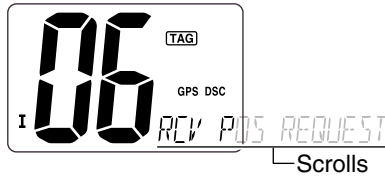

◇ **Receiving a Position Report call**

While monitoring Channel 70 and a Position Report call is received:

- “DSC” appears and “*RCV POS REPORT*” scrolls at the channel comment indicator.
- Push any key to stop the beep, then push [DSC] to reply to the call; push any other key to ignore the call.
 - The ‘Latitude’ and ‘Longitude’ from the called station is displayed and scrolled automatically in order of Latitude co-ordinates and then Longitude co-ordinates after replying the call.

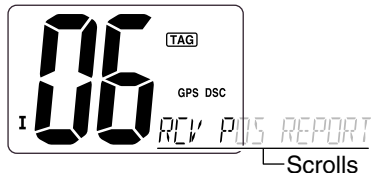

◇ **Receiving a Position Reply call**

While monitoring Channel 70 and a Position Reply call is received:

- “DSC” and “POS REPLY” appear in the display.
 - The ‘Latitude’ and ‘Longitude’ from the called station is displayed and scrolled automatically in order of Latitude co-ordinates and then Longitude co-ordinates.
- Push any key to stop the beep.



◇ **Receiving a Position Report Reply call**

While monitoring Channel 70 and a Position Report Reply call is received:

- “DSC” and “POS REPLY” appear in the display.
 - The ‘Latitude’ and ‘Longitude’ you have sent is displayed and scrolled automatically in order of Latitude co-ordinates and then Longitude co-ordinates.
- Push any key to stop the beep.



■ Set mode programming

Set mode is used to change the conditions of the transceiver's functions: Scan type (Normal or Priority,) Scan resume timer, Weather alert, Dual/Tri-watch, DSC watch, Beep tone, Auto acknowledgement and Favorite channel function.

⚡ Available functions may differ depending on dealer setting.

◇ Set mode operation

- ① Turn power OFF.
- ② While pushing **[16]**, turn power ON to enter Set mode.
- ③ After the display appears, release **[16]**.
 - "SCAN" appears at the channel comment indicator.
- ④ Push **[16]** to select the desired item, if necessary.
- ⑤ Push **[▲]** or **[▼]** to select the desired condition of the item.
- ⑥ Turn power OFF, then ON again to exit Set mode.

◇ Set mode construction

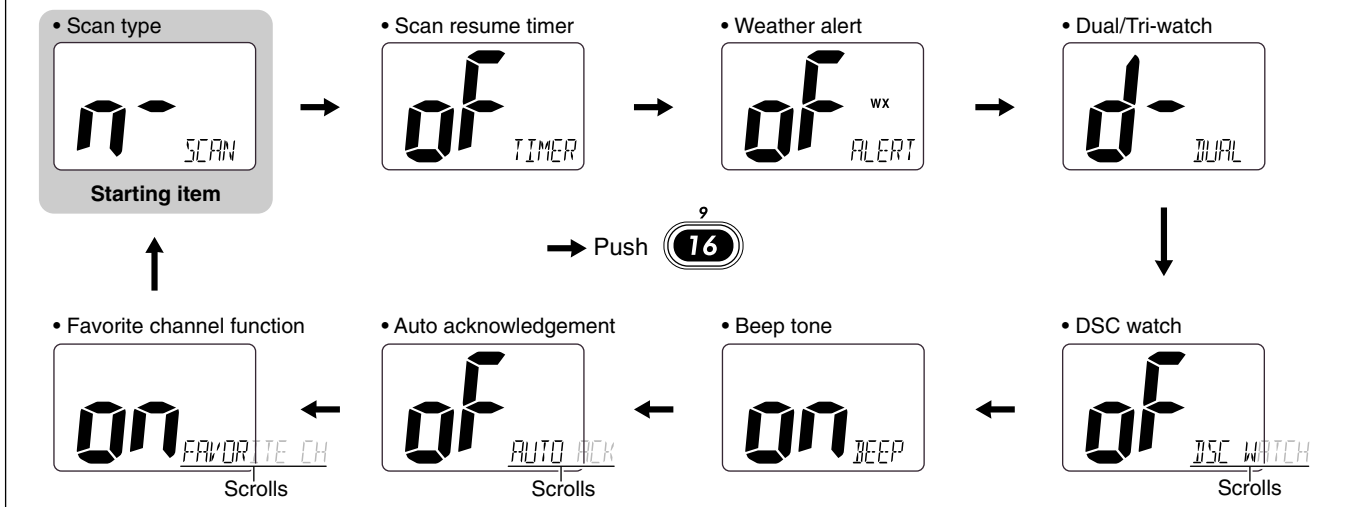

■ Set mode items

◇ Scan type

The transceiver has 2 scan types: Normal scan and Priority scan. Normal scan searches all TAG channels in the selected channel group. Priority scan searches all TAG channels in sequence while monitoring Channel 16.



Normal scan (default)

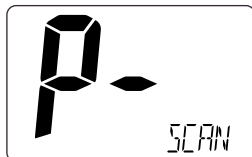

Priority scan

◇ Scan resume timer

The scan resume timer can be selected as a pause (OFF) or timer scan (ON). When OFF is selected, the scan pauses until the signal disappears. When ON is selected, the scan pauses 5 sec. and resumes even if a signal has been received on any other channel than Channel 16.



Scan timer OFF (default)



Scan timer ON

◇ Weather alert

A NOAA broadcast station transmits a weather alert tone before important weather information. When the weather alert function is turned ON, the transceiver detects the alert, then the "WX ALT" indicator blinks until the transceiver is operated. The previously selected (used) weather channel is checked any time while scanning.

• "WX ALT" appears instead of "WX" indication when the function is set ON.



Weather alert OFF (default)



Weather alert ON

◇ Dual/Tri-watch

This item can be selected as Dualwatch or Tri-watch. (p. 12)

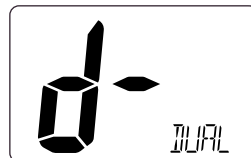

Dualwatch (default)

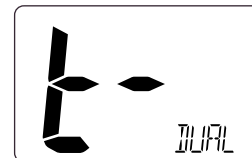

Tri-watch

7 SET MODE

◆ DSC watch

DSC watch monitors Channel 70 while you are receiving another channel.

If a distress signal is received on Channel 70, the transceiver monitors Channel 16 and 70 alternately until the distress signal disappears. If a signal is received on another channel, DSC watch pauses until the signal disappears.

▨ This function may not be available for some channel groups depending on dealer setting.

- “DSC WATCH” scrolls at the channel comment indicator.



DSC watch OFF (default)



DSC watch ON

◆ Beep tone

You can select silent operation by turning beep tones OFF or you can have confirmation beeps sound at the push of a key by turning beep tones ON.



Beep tone ON (default)



Beep tone OFF

◆ Automatic acknowledgement

This item sets the Automatic acknowledgement function ON or OFF.

When Position Request call or Position Report call is received, transceiver automatically transmits Position Request Reply call or Position Report Reply call, respectively.

- “AUTO ACK” scrolls at the channel comment indicator.



Auto acknowledgement
OFF (default)



Auto acknowledgement
ON

◆ Favorite channel

This item sets the Favorite channel function ON or OFF.

The favorite channel is programmed by the TAG channel setting (p. 11).

When the Favorite channel function is turned ON, [▲]/[▼] keys on the microphone select the favorite channels in the selected channel group in sequence when pushed.

- “FAVORITE CH” scrolls at the channel comment indicator.



Favorite CH ON (default)



Favorite CH OFF

■ Connections

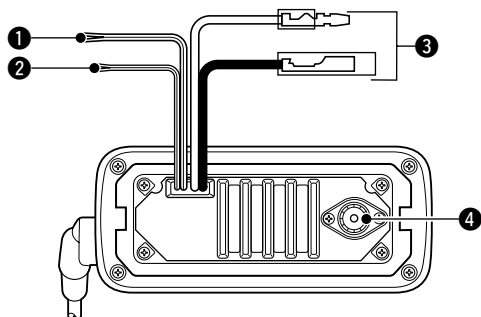

1 EXTERNAL SPEAKER LEAD

Connects to an external speaker.

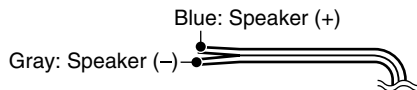

2 GPS RECEIVER LEAD

Connects to a GPS receiver for position indication.

- An NMEA0183 ver. 2.0 or 3.01 (sentence formatters RMC, GGA, GNS, GLL) compatible GPS receiver is required. Ask your dealer about suitable GPS receivers.



3 DC POWER CONNECTOR

Connects the supplied DC power cable from this connector to an external 13.8 V DC power source.

CAUTION: After connecting the DC power cable, GPS receiver lead and external speaker lead, cover the connector and leads with an adhesive tape as shown below, to prevent water seeping into the transceiver.

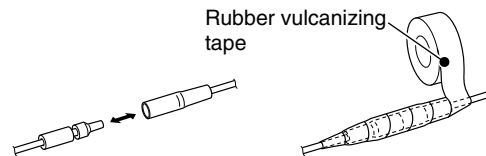

4 ANTENNA CONNECTOR

Connects a marine VHF antenna with a PL-259 connector to the transceiver.

CAUTION: Transmitting without an antenna may damage the transceiver.

■ Supplied accessories

The following accessories are supplied:

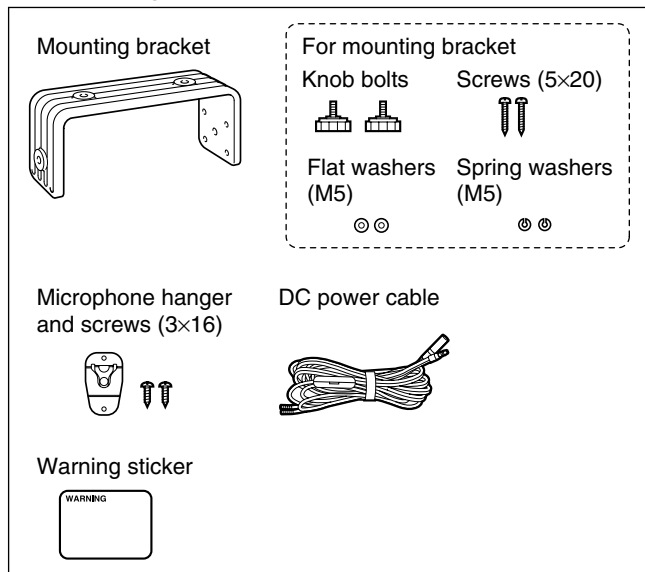

■ Antenna

A key element in the performance of any communication system is the antenna. Ask your dealer about antennas and the best place to mount them.

■ Fuse replacement

One fuse is installed in the supplied DC power cable. If a fuse blows or the transceiver stops functioning, track down the source of the problem, if possible, and replace the damaged fuse with a new, rated one.

■ Cleaning

If the transceiver becomes dusty or dirty, wipe it clean with a soft, dry cloth.



AVOID the use of solvents such as benzene or alcohol, as they may damage transceiver surfaces.

■ Mounting the transceiver

◆ Using the supplied mounting bracket

The universal mounting bracket supplied with your transceiver allows overhead or dashboard mounting.

- Mount the transceiver securely with the 2 supplied screws (5 × 20) to a surface which is more than 10 mm thick and can support more than 5 kg.
- Mount the transceiver so that the face of the transceiver is at 90° to your line of sight when operating it.

/// **CAUTION: KEEP** the transceiver and microphone at least 1 meter away from your vessel's magnetic navigation compass.

/// **NOTE:** Check the installation angle; the function display may not be easy-to-read at some angles.

EXAMPLE

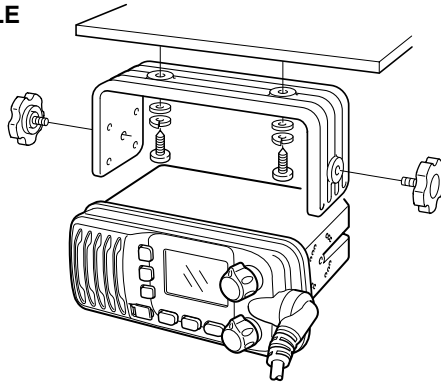

■ Optional MB-92 attachment

An optional MB-92 DUST COVER is available for attaching to the transceiver's front panel to prevent the keys and knobs getting wet when the transceiver is not used.

- Attach the optional MB-92 DUST COVER to the transceiver as shown below.

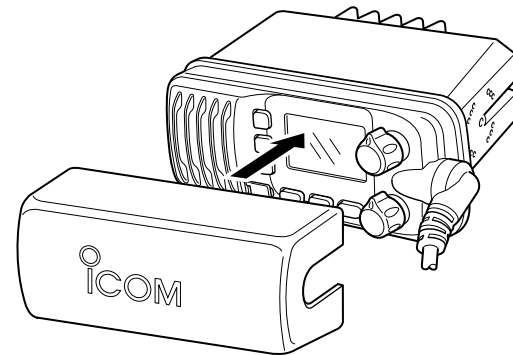

■ Optional MB-69 installation

An optional MB-69 FLUSH MOUNT is available for mounting the transceiver to a flat surface such as an instrument panel.

CAUTION: KEEP the transceiver and microphone at least 1 meter away from your vessel's magnetic navigation compass.

- ① Using the template on p. 39, carefully cut a hole into the instrument panel (or wherever you plan to mount the transceiver.)
- ② Slide the transceiver through the hole as shown below.

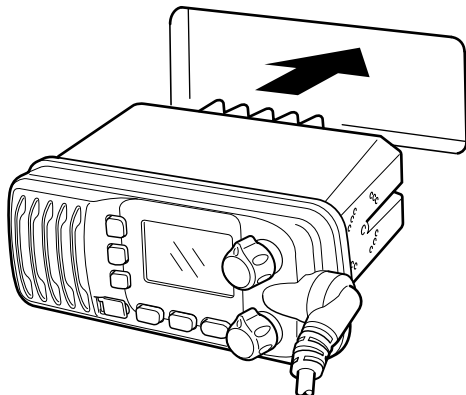

- ③ Attach the clamps on either side of the transceiver with 2 supplied bolts (5×8 mm).
 - Make sure that the clamps align parallel to the transceiver body.

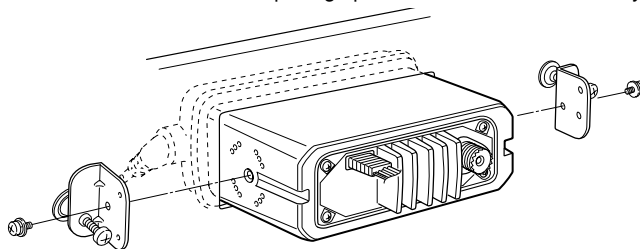

- ④ Tighten the end bolts on the clamps (rotate clockwise) so that the clamps press firmly against the inside of the instrument control panel.
- ⑤ Tighten the locking nuts (rotate counterclockwise) so that the transceiver is securely mounted in position as below.
- ⑥ Connect the antenna and power cable, then return the instrument control panel to its original place.

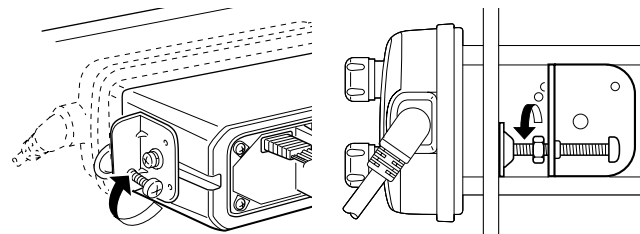

PROBLEM	POSSIBLE CAUSE	SOLUTION	REF.
The transceiver does not turn ON.	<ul style="list-style-type: none"> • Bad connection to the power supply. 	<ul style="list-style-type: none"> • Check the connection to the transceiver. 	p. 31
No sound from speaker.	<ul style="list-style-type: none"> • Squelch level is too high. • Volume level is too low. • Speaker has been exposed to water. 	<ul style="list-style-type: none"> • Set squelch to the threshold point. • Set [VOL] to a suitable level. • Drain water from the speaker. 	<p>p. 7</p> <p>p. 7</p> <p>p. 9</p>
Transmitting is impossible, or high power can not be selected.	<ul style="list-style-type: none"> • Some channels are for low power or receive only. • The output power is set to low. 	<ul style="list-style-type: none"> • Change channels. • Push [HI/LO] on the microphone to select high power. 	<p>pgs. 5,</p> <p>6, 36</p> <p>p. 7</p>
Scan does not start.	<ul style="list-style-type: none"> • “TAG” channel is not programmed. 	<ul style="list-style-type: none"> • Set the desired channels as “TAG” channels. 	p. 11
No beeps.	<ul style="list-style-type: none"> • Beep tones are turned OFF. 	<ul style="list-style-type: none"> • Turn the beep tone ON in Set mode. 	p. 30
Distress call cannot be transmitted.	<ul style="list-style-type: none"> • MMSI (DSC self ID) code is not programmed. 	<ul style="list-style-type: none"> • Program the MMSI (DSC self ID) code. 	p. 13

10 CHANNEL LIST

Channel number			Frequency (MHz)	
USA	INT	CAN	Transmit	Receive
	01	01	156.050	160.650
01A			156.050	156.050
	02	02	156.100	160.700
	03	03	156.150	160.750
03A			156.150	156.150
	04		156.200	160.800
		04A	156.200	156.200
	05		156.250	160.850
05A		05A	156.250	156.250
06	06	06	156.300	156.300
	07		156.350	160.950
07A		07A	156.350	156.350
08	08	08	156.400	156.400
09	09	09	156.450	156.450
10	10	10	156.500	156.500
11	11	11	156.550	156.550
12	12	12	156.600	156.600
13* ²	13	13* ¹	156.650	156.650
14	14	14	156.700	156.700
15* ²	15* ¹	15* ¹	156.750	156.750
16	16	16	156.800	156.800
17* ¹	17	17* ¹	156.850	156.850
	18		156.900	161.500
18A		18A	156.900	156.900
	19		156.950	161.550
19A		19A	156.950	156.950
20	20	20* ¹	157.000	161.600
20A			157.000	157.000

Channel number			Frequency (MHz)	
USA	INT	CAN	Transmit	Receive
	21	21	157.050	161.650
21A		21A	157.050	157.050
		21b	Rx only	161.650
	22		157.100	161.700
22A		22A	157.100	157.100
	23	23	157.150	161.750
23A			157.150	157.150
24	24	24	157.200	161.800
25	25	25	157.250	161.850
		25b	Rx only	161.850
26	26	26	157.300	161.900
27	27	27	157.350	161.950
28	28	28	157.400	162.000
		28b	Rx only	162.000
	60	60	156.025	160.625
	61		156.075	160.675
61A		61A	156.075	156.075
	62		156.125	160.725
		62A	156.125	156.125
	63		156.175	160.775
63A			156.175	156.175
	64	64	156.225	160.825
64A		64A	156.225	156.225
	65		156.275	160.875
65A	65A	65A	156.275	156.275
	66		156.325	160.925
66A	66A	66A* ¹	156.325	156.325
67* ²	67	67	156.375	156.375

Channel number			Frequency (MHz)	
USA	INT	CAN	Transmit	Receive
68	68	68	156.425	156.425
69	69	69	156.475	156.475
70* ³	70* ³	70* ³	156.525	156.525
71	71	71	156.575	156.575
72	72	72	156.625	156.625
73	73	73	156.675	156.675
74	74	74	156.725	156.725
75* ¹	75* ¹	75* ¹	156.775	156.775
76* ¹	76* ¹	76* ¹	156.825	156.825
77* ¹	77	77* ¹	156.875	156.875
	78		156.925	161.525
78A		78A	156.925	156.925
	79		156.975	161.575
79A		79A	156.975	156.975
	80		157.025	161.625
80A		80A	157.025	157.025
	81		157.075	161.675
81A		81A	157.075	157.075
	82		157.125	161.725
82A		82A	157.125	157.125
	83	83	157.175	161.775
83A		83A	157.175	157.175
		83b	Rx only	161.775
84	84	84	157.225	161.825
84A			157.225	157.225
85	85	85	157.275	161.875
85A			157.275	157.275
86	86	86	157.325	161.925

Channel number			Frequency (MHz)	
USA	INT	CAN	Transmit	Receive
86A			157.325	157.325
87	87	87	157.375	161.975
87A			157.375	157.375
88	88	88	157.425	162.025
88A			157.425	157.425

WX channel	Frequency (MHz)	
	Transmit	Receive
1	RX only	162.550
2	RX only	162.400
3	RX only	162.475
4	RX only	162.425
5	RX only	162.450
6	RX only	162.500
7	RX only	162.525
8	RX only	161.650
9	RX only	161.775
10	RX only	163.275

*¹ Low power only. *² Momentary high power. *³ DSC operation only.

NOTE: Simplex channels, 3, 21, 23, 61, 64, 81, 82 and 83 **CANNOT** be lawfully used by the general public in U.S.A. waters.

■ Specifications

◆ General

- Frequency coverage : Transmit 156.025–157.425 MHz
Receive 156.050–163.275 MHz
- Mode : FM (16K0G3E)
DSC (16K0G2B)
- Channel spacing : 25 kHz
- Current drain (at 13.8 V) : TX (at 25 W) 5.5 A max.
Max. audio 1.5 A max.
- Power supply requirement : 13.8 V DC ±15%
- Frequency stability : ±10 ppm
- Operating temperature range: –20°C to +60°C; –4°F to +140°F
- Dimensions : 153(W) × 67(H) × 133(D) mm
(Projections not included) 6 1/32(W) × 2 5/8(H) × 5 1/4(D) in
- Weight : Approx. 825 g ; 1.8 lb

◆ Transmitter

- Output power : 25 W (High) and 1 W (Low)
- Modulation system : Variable reactance frequency modulation
- Max. frequency deviation : ±5.0 kHz
- Spurious emissions : Less than –70 dBc (High)
Less than –56 dBc (Low)
- Adjacent channel power : More than 70 dB

◆ Receiver

- Receive system : Double conversion
superheterodyne
- Sensitivity (12 dB SINAD) : 0.22 μV (typical)
- Squelch sensitivity : Less than 0.22μV
- Intermodulation rejection ratio : More than 70 dB
- Spurious response rejection ratio : More than 70 dB
- Adjacent channel selectivity : More than 70 dB
- Audio output power : 4.5 W (typical) at 10%
distortion with a 4 Ω load

All stated specifications are subject to change without notice or obligation.

11 SPECIFICATIONS

◆ Dimensions

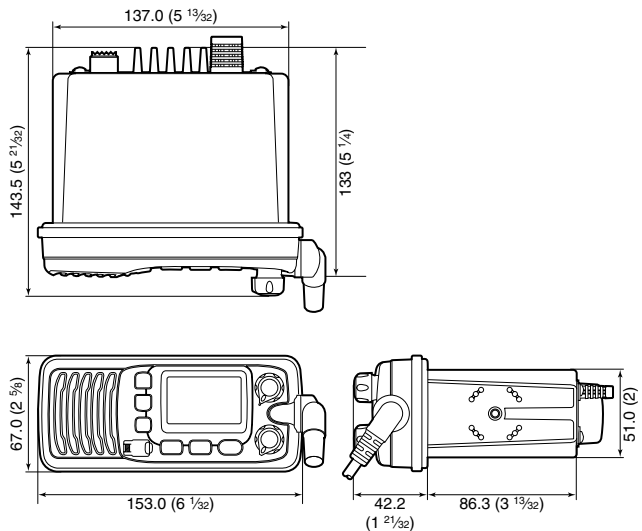

Unit: mm (inch)

■ Options

- **MB-69 FLUSH MOUNT KIT**

For mounting the transceiver to a panel.

- **MB-92 DUST COVER**

For attaching to the front panel of the transceiver to protect it when not in use.

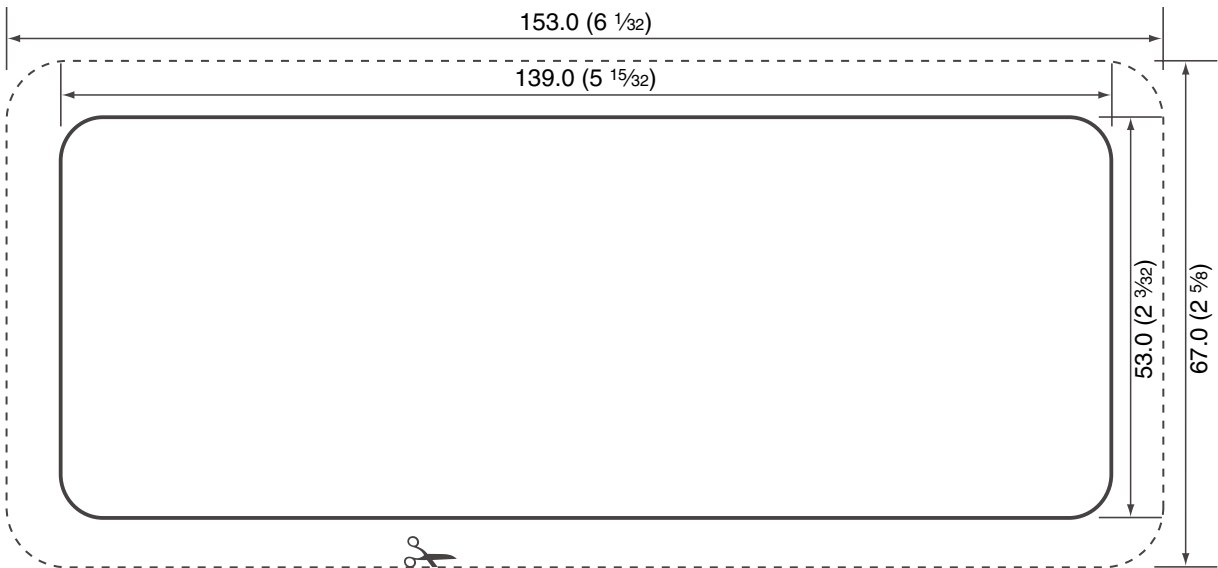

Unit: mm (inch)

Cut here

NOTE: The solid line is the line to use when cutting into the dash/helm. The dotted line shows the outline of the IC-M304's front panel once the radio is fitted into the hole. Do not follow the dotted line when making the hole in your dash/helm.

Count on us!

A-6542D-1US
Printed in Japan
© 2006 Icom Inc.

Icom Inc.
1-1-32 Kamiminami, Hirano-ku, Osaka 547-0003, Japan